

F 102 52x66/52x80 catena COMBINATA - COMBINED chain

SERIE F - F SERIES

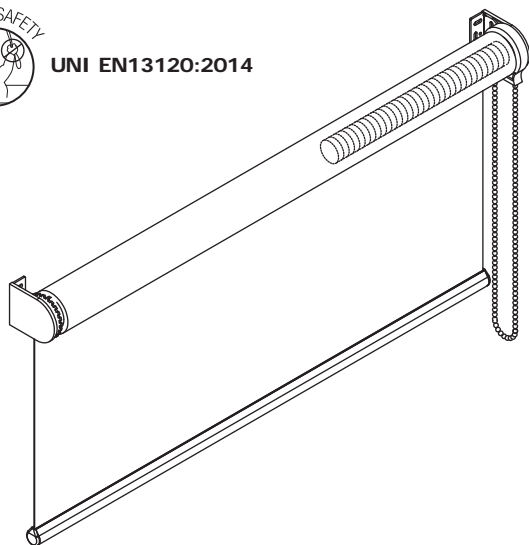

UNI EN13120:2014



dimensioni in mm
dimensions shown in mm

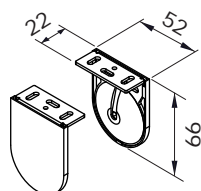

52x66

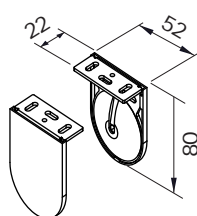

52x80

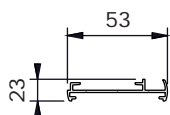

profilo di premontaggio
aluminum frame

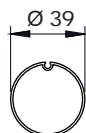

rullo - tube

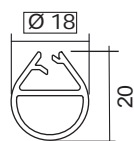

F21 Serie 2012

varianti - optional

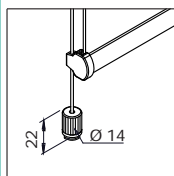

fondale FR23 e cavo perlon
Φ1,2mm con tenditore per
fissaggio piano orizzontale,
con staffe in acciaio per piano
verticale

FR23 hem bar and Φ1.2mm
perlon cable with cable
tensioning block for window
sill/floor mounting or brackets
for wall mounting

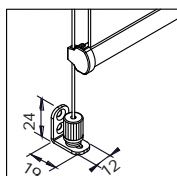

copri staffe magnetici in
alluminio satinato
satin finish aluminium
magnetic bracket covers.

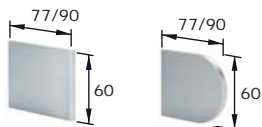

CARATTERISTICHE:

Tipo di applicazione: verticale

Ambiente di applicazione: interno. Larghezza minima 80 cm

Staffe di fissaggio: 52x66 mm in ferro verniciato con copri staffe in PVC (bianco, nero, grigio); staffa 52x80 mm su richiesta. A supplemento copri staffe magnetici in alluminio satinato.

Rullo di avvolgimento: Ø 39 mm in alluminio estruso con ogiva per facilitare la manutenzione del telo

Fondale: F21 Serie 2012 in alluminio estruso con tappi in PVC. Fondale FR23 con la variante guida cavo perlon.

Manovra: a catena combinata con comando frizionato EASY LOCK in PVC completo di calotta lato opposto con perno rientrante per facilitare lo smontaggio del rullo dalle staffe e molla di richiamo per agevolare il sollevamento del telo. Catena passo 6 in nylon con grani in PVC Ø 4,5 mm dotata di sgancio di sicurezza "child safety device" secondo la norma UNI EN13120:2014

Fissaggio: a parete o a soffitto. A supplemento profilo di premontaggio in alluminio estruso verniciato (bianco Ral 9010 - nero Ral 9005 opaco - argento anodizzato)

CHARACTERISTICS:

Application: vertical

Installation: indoors. Minimum width 80 cm

Brackets: 52x66 mm steel powder coated brackets with PVC covers (white, grey, black), 52x80 mm on request. Supplement for satin finish aluminium magnetic bracket covers.

Roller tube: Ø 39 mm extruded aluminum tube with slot to facilitate fabric removal

Hem bar: F21 Serie 2012 extruded aluminum hem bar with PVC caps. FR23 hem bar supplied with guided blind with cable.

Operation: combined chain operation with EASY LOCK control unit and opposite side end plug with retractable pin to easily remove the tube from the brackets and compensating spring to assist roll-up. Ø 4,5 mm PVC/nylon bead chain, 6 mm pitch, with incorporated child safety device - UNI EN13120:2014

Mounting: wall or ceiling. Supplement for powder coated premounting frame (white Ral 9010 - matt black Ral 9005 - silver anodised)

note - notes

fondale in alluminio estruso FR23 in abbinamento alla variante con cavi - guided blind with cables supplied with FR23 extruded aluminium hem bar

il sistema è comprensivo di molla di richiamo che agevola il sollevamento del telo - compensating spring to assist roll-up included

colori standard - standard colours

bianco Ral 9010 - white Ral 9010

avorio Ral 1013 - ivory Ral 1013

marrone Ral 8017 - brown Ral 8017

nero Ral 9005 opaco - matt black Ral 9005

argento anodizzato - silver anodised

tessuti abbinabili - suitable fabrics

da utilizzare con tessuti superiori a 350 g/m²
per l'utilizzo dei tessuti consultare la sezione dei teli confezionati e/o Tabella "A"
Suitable for heavy fabrics (over 350 g/m²)
for fabric choice consult the fabric section and Tab. "A"

supplementi - supplement

